

Fresco EzPro
User Manual

Model: WF007

Please read this manual carefully before use.
Keep the manual in a safe place for future reference.

01 / Inside the box



Fountain*1



Base*1



Filter*1



Foam*1



Manual*1

02 / Meet your smart fountain

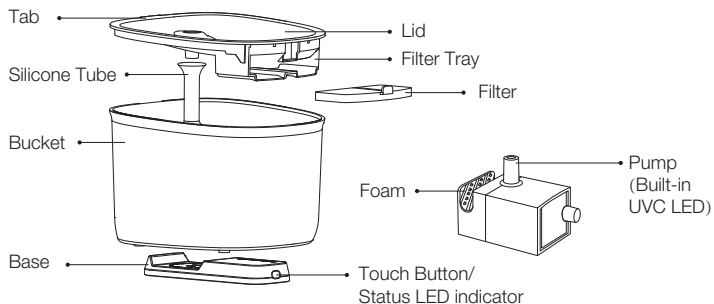

How sterilization works:

When the pump starts each time, the UVC LED sterilizes for 40 minutes, rests for 20 minutes, and then works for 15 minutes every hour followed by a 45-minute rest period.

03 / Operations

① Clean up

The bucket, lid, and filter tray are washable.

Wipe or dry the surface of the bucket before use.

Do not wash the base.

Rinse and soak the filter in clean water for 5 minutes.

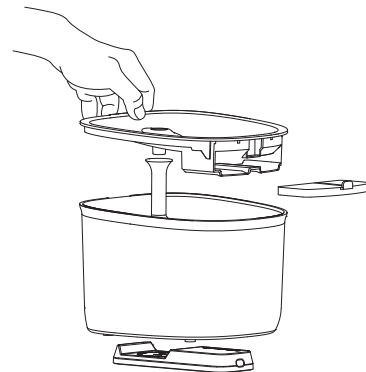

② Fill up

When pouring, ensure the water does not exceed the maximum water level line.

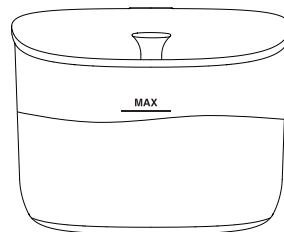

③ Assemble

Assemble the filter tray, filter and lid according to the illustration and put them in the bucket.

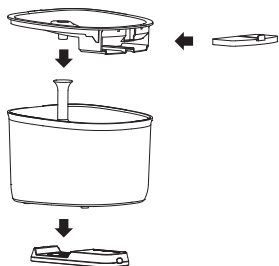

⑤ Accessories replacing

It is recommended to replace the filter and foam every 30 days.

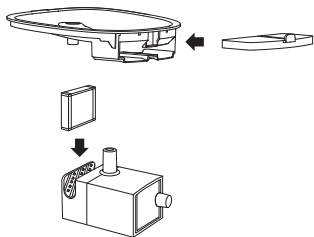

④ Power on

Connect the cable to the power adaptor, then plug it into the wall outlet.

*The adaptor (USB 5V 1A) is not included; please find a spare one.

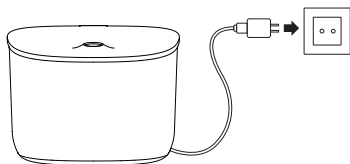

⑥ Connect the fountain

Download the Petoneer app and connect the fountain to your Wi-Fi to monitor and control.

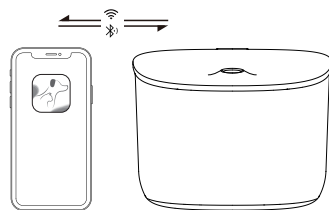

04 / Quick Setup

1 Scan the QR code on the right and download the Petoneer App which is available on App Store and Google Play. Click Sign up to get walked through to create your Petoneer account.



2 Power on and ensure the Wi-Fi Indicator LED is blinking fast reflecting the device is ready for joining the Wi-Fi.

Open the Petoneer App and click the '+' button and get walked through the SET-UP steps.

Notice:

- 1) The fountain doesn't support the 5GHz Wi-Fi, please make sure your Wi-Fi is 2.4G.
- 2) If the Wi-Fi indicator is not blinking fast after power-on, please long press the touch button until the indicator blinks quickly.

05 / Button & Status Indicator Explained

Status LED Indicator	Steady blue	Connected/ normal mode
	Blinks in blue	Disconnected/ ready for setup
	Breathes in blue	Geyser mode
	Steady red	Low water/ no water
	Blinks in red	Filter expired
Touch Button	Short press for 1 second	Swith working mode
	Long press for 3 seconds	Filter replaced
	Long press for 5 seconds	Factory reset

06 / Specifications

Description: Fresco EzPro

Model No.: WF007

Dimension: 195*192*140mm

Material: ABS

UVC LED Life: 6000-8000 Hours

Input Voltage: 5V == 1A

Capacity: 2.0L

Warranty: 1 year

Net Weight: 20.74 oz(588g)

UVC Wavelength: 260-280nm

07 / Precautions

1. Use the product in the indoor environment;
2. Place the product on the level of the ground to avoid it tipping over, spilling and improperly operating.
3. Disconnect the power supply when cleaning the whole machine or changing the water.
4. Clean the base with a dry cloth and do not soak it.
5. Keep the charging surface clear of any metal or foreign objects!
6. Please shield or organize the power cord well to prevent the pet from biting it.
7. Low water reminder does not work if the fountain is not working. When there is water by default and the fountain is working, it will alert when water is detected low.
8. This fountain is suitable for cats or small and medium-size dogs.
9. As UVC ultraviolet light cannot penetrate plastic or clothing, the ultraviolet light emitted by this device during operation will not affect users and pets.
10. After long-term use, the aging and yellowing of the water pump casing exposed to ultraviolet light is a normal phenomenon.

08 / Warranty Terms

Within the period of warranty, if the product fails with no fault of user operations, it will be repaired at Petoneer's expense. Repairs resulting from the following conditions are not included in the warranty terms.

- 1) Damage caused by intentional actions.
- 2) Failure by not in accordance with the (QIG) Quick Installation Guide Instruction for the use and maintenance of the product.

3) Failure by natural wear and tear including but not limited to scratching, corrosion, oxidation and rusting.

4) Failure by repair, modification or cleaning at a non-Petoneer authorized third party or by the user's own.

(In order to provide better products, we make regular product improvements. All Pictures shown in the manual are for illustration purpose only. Actual product may vary due to product enhancement.)

Manufacturer: SkyRC Technology Co. Ltd.

Address: Floor 4,5,8, Building 4, Meitai Industrial Park, Guanguang Road, Guanlan, Longhua District, Shenzhen, China, 518110.

FCC Note

This device complies with part 15 of the FCC Rules. Operation is subject to the following two conditions: (1) This device may not cause harmful interference, and (2) this device must accept any interference received, including interference that may cause undesired operation.

Note: The Grantee is not responsible for any changes or modifications not expressly approved by the party responsible for compliance. such modifications could void the user's authority to operate the equipment.

Note: This equipment has been tested and found to comply with the limits for a Class B digital device, pursuant to part 15 of the FCC Rules. These limits are designed to provide reasonable protection against harmful interference in a residential installation. This equipment generates, uses and can radiate radio frequency energy and, if not installed and used in accordance with the instructions, may cause harmful interference to radio communications.

However, there is no guarantee that interference will not occur in a particular installation. If this equipment does cause harmful interference to radio or television reception, which can be determined by turning the equipment off and on, the user is encouraged to try to correct the interference by one or more of the following measures:

—Reorient or relocate the receiving antenna.

—Increase the separation between the equipment and receiver.

—Connect the equipment into an outlet on a circuit different from that to which the receiver is connected.

—Consult the dealer or an experienced radio/TV technician for help.

FCC Radiation Exposure Statement

The equipment complies with FCC Radiation exposure limits set forth for uncontrolled environment.

This equipment should be installed and operated with minimum distance 20cm between the radiator and your body.

Environmental Conditions

Operating Temperature: 32 °F to 104 °F, (0 °C to 40 °C) (indoor only).

SkyRC Technology Co., Ltd. declares that this Fresco EzPro (WF007), is in compliance with the essential requirements and other relevant provisions of the Radio Equipment Directive (2014/53/EU).

Environment friendly disposal

You can help protect the environment!

Please remember to respect your local regulations: dispose of nonfunctional electrical equipment with an appropriate waste disposal center.



Manufacturer: SkyRC Technology Co., Ltd.

4, 5, 8 Floor, Building 4, Meitai Science Park, Guanguang Road, Guanlan, Longhua District, Shenzhen, China.

09 / Read all the instructions

When using electrical appliances, basic safety precautions should always be followed, including the following:

1. Do not touch hot surfaces. Use handles.
2. To protect against electric shock do not immerse cord, plug into water or other liquid.
3. Close supervision is necessary when any appliance is used by or near children.
4. Unplug from outlet when not in use and before cleaning. Allow to cool before putting on or taking off parts, and before cleaning the appliance.
5. Do not operate any appliance with a damaged cord or plug, should the appliance malfunction, or if it has been damaged in any manner. Return appliance to the nearest authorized service facility for examination, repair or adjustment.
6. The use of the accessory attachments is not recommended by the appliance manufacturer as it may cause injuries.
7. Do not use outdoors.
8. Do not let the cord hang over edge of table or counter, or touch hot surfaces.
9. Do not place on or near a hot gas or electric burner, or in a heated oven.
10. Always attach plug to appliance first, then plug cord in the wall outlet.
11. Do not use the appliance for other than intended use.
12. WARNING: Never leave the appliance unattended whilst in use.

13. Warning: keep the supply cord away from heating tip and metal enclosure while using.

14. This appliance is not intended for use by persons (including children) with reduced.

physical, sensory or mental capabilities, or lack of experience and knowledge, unless they have been given supervision or instructions concerning use of the appliance by a person responsible for their safety.

15. Children should be supervised to ensure that they do not play with the appliance.

16. If the SUPPLY CORD is damaged, it must be replaced by the manufacturer, its service agent or similarly qualified persons in order to avoid a hazard.

17. WARNING: This tool must be placed on its stand when not in use.

SAVE THESE INSTRUCTIONS.

Manufacturer: SkyRC Technology Co., Ltd.

Address: Floors 4, 5, & 8, Building 4, Meitai Technology Park, Guanguang South Road, Guanlan, Longhua District, Shenzhen, China